

SN74LV1T04 Single Power Supply Inverter Gate CMOS Logic Level Shifter

1 Features

- Single-Supply Voltage Translator at 5.0/3.3/2.5/1.8V V_{CC}
- Operating Range of 1.8V to 5.5V
- Up Translation
 - 1.2V⁽¹⁾ to 1.8V at 1.8V V_{CC}
 - 1.5V⁽¹⁾ to 2.5V at 2.5V V_{CC}
 - 1.8V⁽¹⁾ to 3.3V at 3.3V V_{CC}
 - 3.3V to 5.0V at 5.0V V_{CC}
- Down Translation
 - 3.3V to 1.8V at 1.8V V_{CC}
 - 3.3V to 2.5V at 2.5V V_{CC}
 - 5.0V to 3.3V at 3.3V V_{CC}
- Logic Output is Referenced to V_{CC}
- Output Drive
 - 8mA Output Drive at 5V
 - 7mA Output Drive at 3.3V
 - 3mA Output Drive at 1.8V
- Characterized up to 50MHz at 3.3V V_{CC}
- 5V Tolerance on Input Pins
- –40°C to 125°C Operating Temperature Range
- Pb-Free Packages Available: SC-70 (DCK)
 - 2 × 2.1 × 0.65 mm (Height 1.1mm)
- Latch-Up Performance Exceeds 250mA Per JESD 17
- ESD Performance Tested Per JESD 22
 - 2000-V Human-Body Model (A114-B, Class II)
 - 200-V Machine Model (A115-A)
 - 1000-V Charged-Device Model (C101)
- Supports Standard Logic Pinouts
- CMOS Output B Compatible with AUP1G and LVC1G Families

⁽¹⁾ Refer to the V_{IH}/V_{IL} and output drive for lower V_{CC} condition.

2 Applications

- Industrial controllers
- Telecom
- Portable applications
- Servers
- PC and notebooks
- Automotive

3 Description

SN74LV1T04 is a low voltage CMOS gate logic that operates at a wider voltage range for industrial, portable, telecom, and automotive applications. The output level is referenced to the supply voltage and is able to support 1.8V/2.5V/3.3V/5V CMOS levels.

The input is designed with a lower threshold circuit to match 1.8V input logic at $V_{CC} = 3.3V$ and can be used in 1.8V to 3.3V level up translation. In addition, the 5V tolerant input pins enable down translation (e.g. 3.3V to 2.5V output at $V_{CC} = 2.5V$). The wide V_{CC} range of 1.8V to 5.5V allows generation of desired output levels to connect to controllers or processors.

The SN74LV1T04 is designed with current-drive capability of 8 mA to reduce line reflections, overshoot, and undershoot caused by high-drive outputs.

Device Information

ORDER NUMBER	PACKAGE	BODY SIZE
SN74LV1T04DBVR	SOT-23 (5)	2,90mm x 1,60mm
SN74LV1T04DCKR	SC70 (5)	2,00mm x 1,25mm

DCK or DBV PACKAGE
(TOP VIEW)

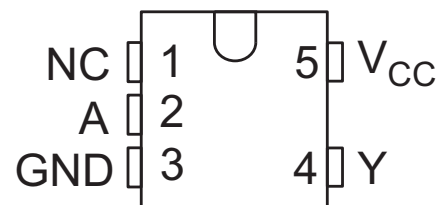

Table of Contents

1 Features	1	4.6 Operating Characteristics	7
2 Applications	1	5 Parameter Measurement Information	8
3 Description	1	5.1 More Product Selection	8
4 Revision History	2	6 Device and Documentation Support	9
4.1 Typical Design Examples	5	6.1 Trademarks	9
4.2 Absolute Maximum Ratings	5	6.2 Electrostatic Discharge Caution	9
4.3 Recommended Operating Conditions	6	6.3 Glossary	9
4.4 Electrical Characteristics	6	7 Mechanical, Packaging, and Orderable	
4.5 Switching Characteristics	7	Information	9

4 Revision History

NOTE: Page numbers for previous revisions may differ from page numbers in the current version.

Changes from Original (September 2013) to Revision A Page

- Updated V_{CC} values for V_{IH} parameter in the ELECTRICAL CHARACTERISTICS table. **6**

Changes from Revision A (September 2013) to Revision B Page

- Updated document formatting. **1**

Function Table

INPUT (Lower Level Input)	OUTPUT (V _{CC} CMOS)
A	Y
H	L
L	H
SUPPLY V _{CC} = 3.3V	
A	Y
V _{IH} (min) = 1.35 V V _{IL} (max) = 0.8 V	V _{OH} (min) = 2.9 V V _{OL} (max) = 0.2 V

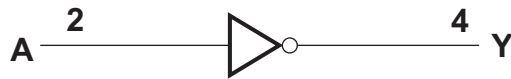

Figure 1. Logic Diagram (NAND Gate)

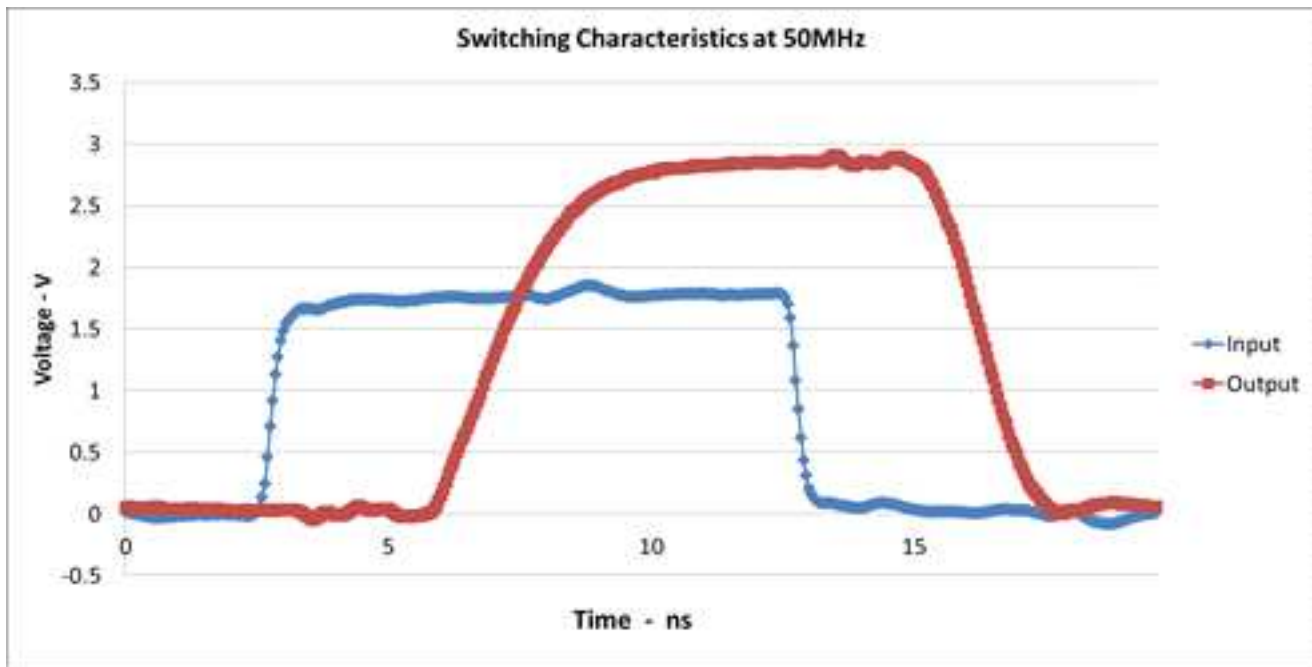

Figure 2. Excellent Signal Integrity (1.8V to 3.3V at 3.3V V_{CC})

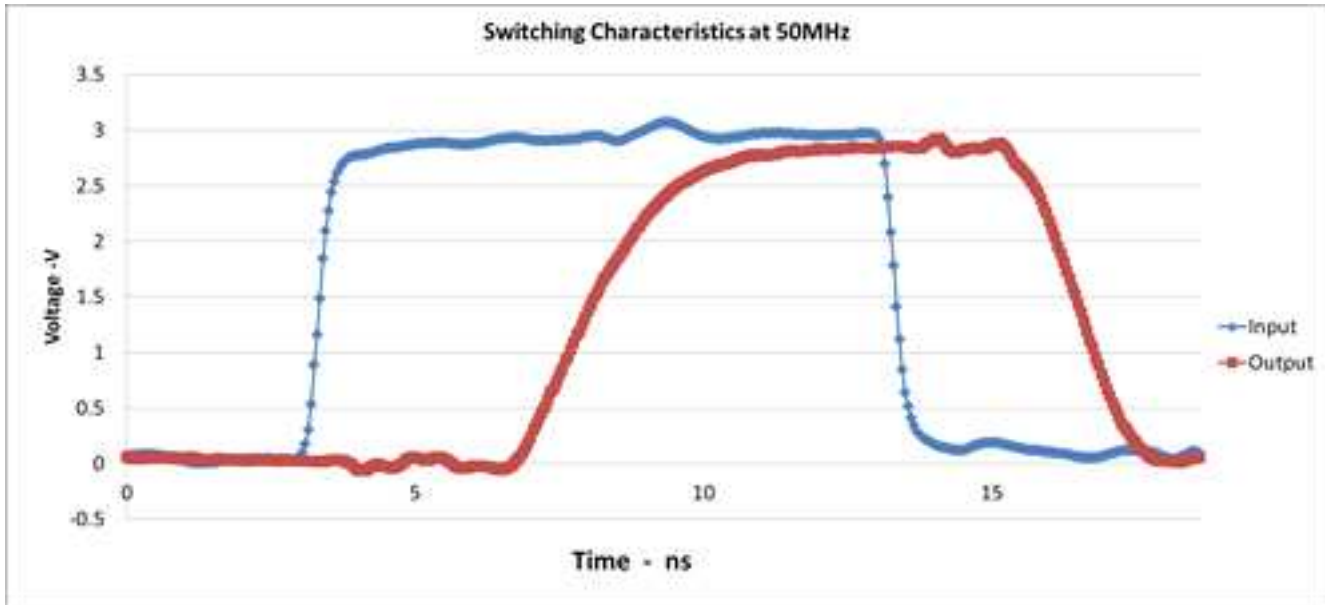

Figure 3. Excellent Signal Integrity (3.3V to 3.3V at 3.3V V_{CC})

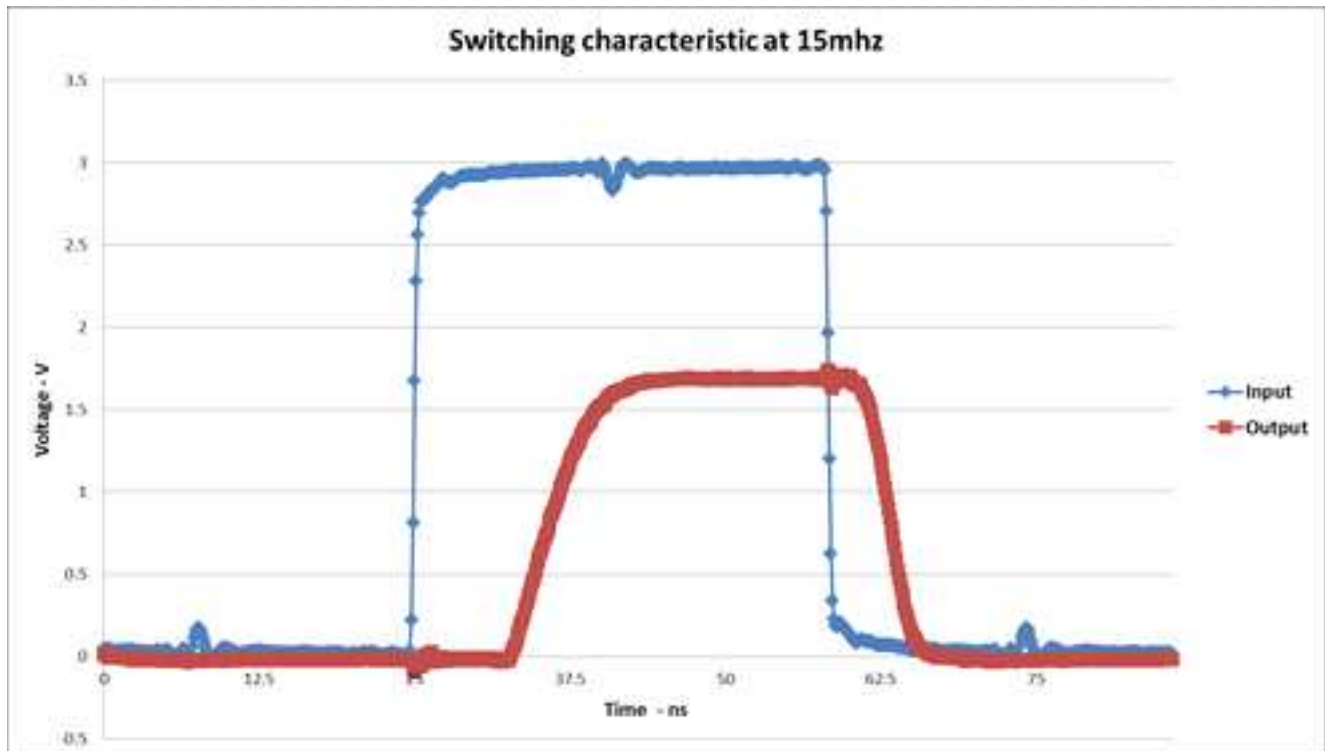

Figure 4. Excellent Signal Integrity (3.3V to 1.8V at 1.8V V_{CC})

4.1 Typical Design Examples

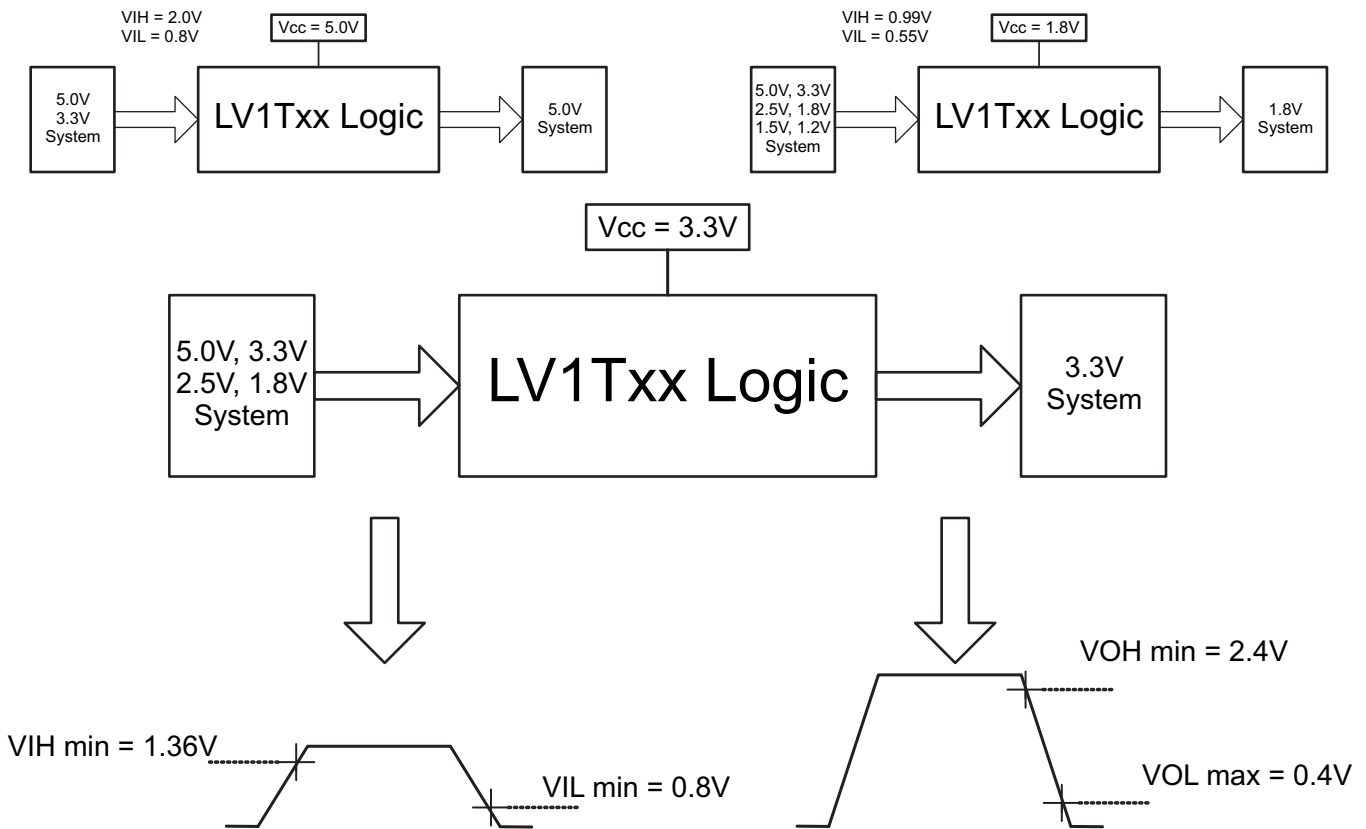

Figure 5. Switching Thresholds for 1.8-V to 3.3-V Translation

4.2 Absolute Maximum Ratings⁽¹⁾

over operating free-air temperature range (unless otherwise noted)

		MIN	MAX	UNIT
V _{CC}	Supply voltage range	-0.5	7.0	V
V _I	Input voltage range ⁽²⁾	-0.5	7.0	V
V _O	Voltage range applied to any output in the high-impedance or power-off state ⁽²⁾	-0.5	4.6	V
	Voltage range applied to any output in the high or low state ⁽²⁾	-0.5	V _{CC} + 0.5	V
I _{IK}	Input clamp current	V _I < 0		-20 mA
I _{OK}	Output clamp current	V _O < 0 or V _O > V _{CC}		±20 mA
I _O	Continuous output current			±25 mA
	Continuous current through VCC or GND			±50 mA
θ _{JA}	Package thermal impedance ⁽³⁾	DBV package		206
		DCK package		252 °C/W
T _{stg}	Storage temperature range	-65	150	°C

(1) Stresses beyond those listed under "absolute maximum ratings" may cause permanent damage to the device. These are stress ratings only, and functional operation of the device at these or any other conditions beyond those indicated under "recommended operating conditions" is not implied. Exposure to absolute-maximum-rated conditions for extended periods may affect device reliability.

(2) The input negative-voltage and output voltage ratings may be exceeded if the input and output current ratings are observed.

(3) The package thermal impedance is calculated in accordance with JESD 51-7.

4.3 Recommended Operating Conditions⁽¹⁾

over operating free-air temperature range (unless otherwise noted)

		MIN	MAX	UNIT	
V_{CC}	Supply voltage	1.6	5.5	V	
V_I	Input voltage	0	5.5	V	
V_O	Output voltage	0	V_{CC}	V	
I_{OH}	High-level output current	$V_{CC} = 1.8\text{ V}$		-3	mA
		$V_{CC} = 2.5\text{ V}$		-5	
		$V_{CC} = 3.3\text{ V}$		-7	
		$V_{CC} = 5.0\text{ V}$		-8	
I_{OL}	Low-level output current	$V_{CC} = 1.8\text{ V}$		3	mA
		$V_{CC} = 2.5\text{ V}$		5	
		$V_{CC} = 3.3\text{ V}$		7	
		$V_{CC} = 5.0\text{ V}$		8	
$\Delta t/\Delta v$	Input transition rise or fall rate	$V_{CC} = 1.8\text{ V}$		20	ns/V
		$V_{CC} = 3.3\text{ V or }2.5\text{ V}$		20	
		$V_{CC} = 5.0\text{ V}$		20	
T_A	Operating free-air temperature	-40	125	°C	

(1) All unused inputs of the device must be held at V_{CC} or GND to ensure proper device operation. Refer to the TI application report, *Implications of Slow or Floating CMOS Inputs*, literature number [SCBA004](#).

4.4 Electrical Characteristics

over recommended operating free-air temperature range (unless otherwise noted)

PARAMETER	TEST CONDITIONS	V_{CC}	$T_A = 25^\circ\text{C}$			$T_A = -40^\circ\text{C to }125^\circ\text{C}$		UNIT
			MIN	TYP	MAX	MIN	MAX	
V_{IH}	High-level input voltage	$V_{CC} = 1.65\text{ V to }1.8\text{ V}$	0.94			1.0		V
		$V_{CC} = 2.0\text{ V}$	1.02			1.03		
		$V_{CC} = 2.25\text{ V to }2.5\text{ V}$	1.135			1.18		
		$V_{CC} = 2.75\text{ V}$	1.21			1.23		
		$V_{CC} = 3\text{ V to }3.3\text{ V}$	1.35			1.37		
		$V_{CC} = 3.6\text{ V}$	1.47			1.48		
		$V_{CC} = 4.5\text{ V to }5.0\text{ V}$	2.02			2.03		
		$V_{CC} = 5.5\text{ V}$	2.1			2.11		
V_{IL}	Low-level input voltage	$V_{CC} = 1.65\text{ V to }2.0\text{ V}$			0.58	0.55	V	
		$V_{CC} = 2.25\text{ V to }2.75\text{ V}$			0.75	0.71		
		$V_{CC} = 3\text{ V to }3.6\text{ V}$			0.8	0.65		
		$V_{CC} = 4.5\text{ V to }5.5\text{ V}$			0.8	0.8		
V_{OH}	$I_{OH} = -20\ \mu\text{A}$	1.65 V to 5.5 V	$V_{CC} - 0.1$			$V_{CC} - 0.1$	V	
	$I_{OH} = -2.0\text{ mA}$	1.65 V	1.28		1.21		V	
		1.8V	1.5		1.45		V	
	$I_{OH} = -2.3\text{ mA}$	2.3V	2		2		V	
	$I_{OH} = -3\text{ mA}$		2		1.93		V	
	$I_{OH} = -3\text{ mA}$	2.5V	2.25		2.15		V	
	$I_{OH} = -3.0\text{ mA}$		2.78		2.7		V	
	$I_{OH} = -5\text{ mA}$	3.0 V	2.6		2.49		V	
	$I_{OH} = -5\text{ mA}$	3.3 V	2.9		2.8		V	
	$I_{OH} = -4\text{ mA}$		4.2		4.1		V	
$I_{OH} = -8\text{ mA}$	4.5 V	4.1		3.95		V		
$I_{OH} = -8\text{ mA}$	5.0 V	4.6		4.5		V		

Electrical Characteristics (continued)

over recommended operating free-air temperature range (unless otherwise noted)

PARAMETER	TEST CONDITIONS	V _{CC}	T _A = 25°C			T _A = –40°C to 125°C		UNIT	
			MIN	TYP	MAX	MIN	MAX		
V _{OL}	I _{OL} = 20 μA	1.65 V to 5.5 V			0.1		0.1		
	I _{OL} = 1.9 mA	1.65 V			0.2		0.25		
	I _{OH} = 2.3 mA	2.3V			0.1		0.15		
	I _{OH} = 3 mA				0.15		0.2		
	I _{OL} = 3 mA	3.0 V			0.1		0.15		
	I _{OL} = 5.5 mA				0.2		0.252	V	
	I _{OL} = 4 mA	4.5 V			0.15		0.2		
I _{OL} = 8 mA				0.3		0.35			
I _I	A input	V _I = 0 V or V _{CC}			0.12		±1	μA	
I _{CC}	V _I = 0 V or V _{CC} , I _O = 0; open on loading	5.0 V			1		10	μA	
		3.3 V			1		10		
		2.5 V			1		10		
		1.8V			1		10		
ΔI _{CC}	One input at 0.3V or 3.4V, Other inputs at 0 or V _{CC} , I _O = 0	5.5 V			1.35		1.5	mA	
	One input at 0.3V or 1.1V Other inputs at 0 or V _{CC} , I _O = 0	1.8V			10		10	μA	
C _i	V _I = V _{CC} or GND	3.3 V			2	10	2	10	pF
C _o	V _O = V _{CC} or GND	3.3 V			2.5		2.5		pF

4.5 Switching Characteristics

over recommended operating free-air temperature range (unless otherwise noted) (see Figure 7)

PARAMETER	FROM (INPUT)	TO (OUTPUT)	FREQUENCY (TYP)	V _{CC}	C _L	T _A = 25°C			T _A = –65°C to 125°C			UNIT	
						MIN	TYP	MAX	MIN	TYP	MAX		
t _{pd}	Any In	Y	DC to 50 MHz	5.0V	15pF			4	5		4	5	ns
					30pF			5.5	7.0		5.5	7.0	
				3.3V	15pF			4.8	5		5	5.5	ns
					30pF			5	5.5		5.5	6.5	
			DC to 25 MHz	2.5V	15pF			6	6.5		7	7.5	ns
					30pF			6.5	7.5		7.5	8.5	
			DC to 15 MHz	1.8V	15pF			10.5	11		11	12	ns
					30pF			12	13		12	14	

4.6 Operating Characteristics

T_A = 25°C

PARAMETER	TEST CONDITIONS	V _{CC}	TYP	UNIT
C _{pd} Power dissipation capacitance	f = 1 MHz and 10 MHz	1.8 V ± 0.15 V	10	pF
		2.5 V ± 0.2 V	10	
		3.3 V ± 0.3 V	10	
		5.5 V ± 0.5 V	10	

5 Parameter Measurement Information

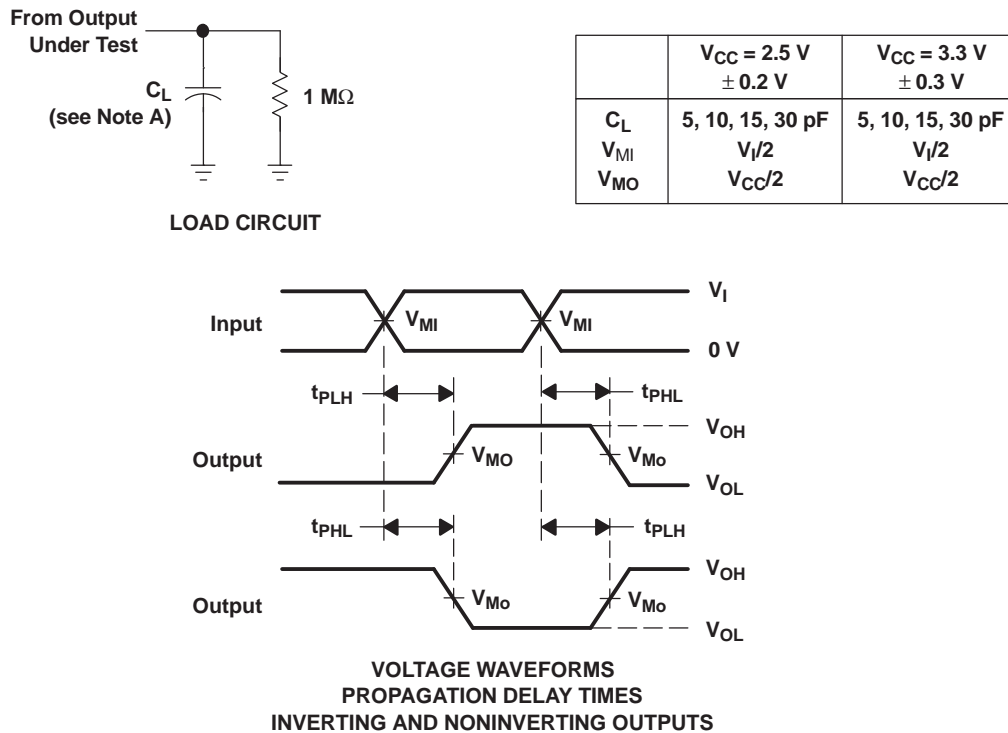

- NOTES: A. C_L includes probe and jig capacitance.
 B. All input pulses are supplied by generators having the following characteristics: PRR ≤ 10 MHz, $Z_O = 50 \Omega$, slew rate ≥ 1 V/ns.
 C. The outputs are measured one at a time, with one transition per measurement.
 D. t_{PLH} and t_{PHL} are the same as t_{pd} .

Figure 6. Load Circuit and Voltage Waveforms

5.1 More Product Selection

DEVICE	PACKAGE	DESCRIPTION
SN74LV1T00	DCK, DBV	2-Input Positive-NAND Gate
SN74LV1T02	DCK, DBV	2-Input Positive-NOR Gate
SN74LV1T04	DCK, DBV	Inverter Gate
SN74LV1T08	DCK, DBV	2-Input Positive-AND Gate
SN74LV1T17	DCK, DBV	Single Buffer Gate with 3-state Output
SN74LV1T14	DCK, DBV	Single Schmitt-Trigger Inverter Gate
SN74LV1T32	DCK, DBV	2-Input Positive-OR Gate
SN74LV1T50	DCK, DBV	Single Buffer Gate with 3-state Output
SN74LV1T86	DCK, DBV	Single 2-Input Exclusive-Or Gate
SN74LV1T125	DCK, DBV	Single Buffer Gate with 3-state Output
SN74LV1T126	DCK, DBV	Single Buffer Gate with 3-state Output
SN74LV4T125	RGY, PW	Quadruple Bus Buffer Gate With 3-State Outputs

6 Device and Documentation Support

6.1 Trademarks

All trademarks are the property of their respective owners.

6.2 Electrostatic Discharge Caution



These devices have limited built-in ESD protection. The leads should be shorted together or the device placed in conductive foam during storage or handling to prevent electrostatic damage to the MOS gates.

6.3 Glossary

[SLYZ022](#) — *TI Glossary*.

This glossary lists and explains terms, acronyms and definitions.

7 Mechanical, Packaging, and Orderable Information

The following packaging information and addendum reflect the most current data available for the designated devices. This data is subject to change without notice and revision of this document.

PACKAGING INFORMATION

Orderable Device	Status (1)	Package Type	Package Drawing	Pins	Package Qty	Eco Plan (2)	Lead/Ball Finish (6)	MSL Peak Temp (3)	Op Temp (°C)	Device Marking (4/5)	Samples
SN74LV1T04DBVR	ACTIVE	SOT-23	DBV	5	3000	Green (RoHS & no Sb/Br)	CU NIPDAU CU SN	Level-1-260C-UNLIM	-40 to 125	(NEC3, NECS)	Samples
SN74LV1T04DCKR	ACTIVE	SC70	DCK	5	3000	Green (RoHS & no Sb/Br)	CU NIPDAU	Level-1-260C-UNLIM	-40 to 125	(WC3, WCS)	Samples

(1) The marketing status values are defined as follows:

ACTIVE: Product device recommended for new designs.

LIFEBUY: TI has announced that the device will be discontinued, and a lifetime-buy period is in effect.

NRND: Not recommended for new designs. Device is in production to support existing customers, but TI does not recommend using this part in a new design.

PREVIEW: Device has been announced but is not in production. Samples may or may not be available.

OBSOLETE: TI has discontinued the production of the device.

(2) **RoHS:** TI defines "RoHS" to mean semiconductor products that are compliant with the current EU RoHS requirements for all 10 RoHS substances, including the requirement that RoHS substance do not exceed 0.1% by weight in homogeneous materials. Where designed to be soldered at high temperatures, "RoHS" products are suitable for use in specified lead-free processes. TI may reference these types of products as "Pb-Free".

RoHS Exempt: TI defines "RoHS Exempt" to mean products that contain lead but are compliant with EU RoHS pursuant to a specific EU RoHS exemption.

Green: TI defines "Green" to mean the content of Chlorine (Cl) and Bromine (Br) based flame retardants meet JS709B low halogen requirements of <=1000ppm threshold. Antimony trioxide based flame retardants must also meet the <=1000ppm threshold requirement.

(3) MSL, Peak Temp. - The Moisture Sensitivity Level rating according to the JEDEC industry standard classifications, and peak solder temperature.

(4) There may be additional marking, which relates to the logo, the lot trace code information, or the environmental category on the device.

(5) Multiple Device Markings will be inside parentheses. Only one Device Marking contained in parentheses and separated by a "~" will appear on a device. If a line is indented then it is a continuation of the previous line and the two combined represent the entire Device Marking for that device.

(6) Lead/Ball Finish - Orderable Devices may have multiple material finish options. Finish options are separated by a vertical ruled line. Lead/Ball Finish values may wrap to two lines if the finish value exceeds the maximum column width.

Important Information and Disclaimer:The information provided on this page represents TI's knowledge and belief as of the date that it is provided. TI bases its knowledge and belief on information provided by third parties, and makes no representation or warranty as to the accuracy of such information. Efforts are underway to better integrate information from third parties. TI has taken and continues to take reasonable steps to provide representative and accurate information but may not have conducted destructive testing or chemical analysis on incoming materials and chemicals. TI and TI suppliers consider certain information to be proprietary, and thus CAS numbers and other limited information may not be available for release.

In no event shall TI's liability arising out of such information exceed the total purchase price of the TI part(s) at issue in this document sold by TI to Customer on an annual basis.

TAPE AND REEL INFORMATION



QUADRANT ASSIGNMENTS FOR PIN 1 ORIENTATION IN TAPE



*All dimensions are nominal

Device	Package Type	Package Drawing	Pins	SPQ	Reel Diameter (mm)	Reel Width W1 (mm)	A0 (mm)	B0 (mm)	K0 (mm)	P1 (mm)	W (mm)	Pin1 Quadrant
SN74LV1T04DBVR	SOT-23	DBV	5	3000	178.0	9.2	3.3	3.23	1.55	4.0	8.0	Q3
SN74LV1T04DBVR	SOT-23	DBV	5	3000	180.0	8.4	3.23	3.17	1.37	4.0	8.0	Q3
SN74LV1T04DCKR	SC70	DCK	5	3000	180.0	8.4	2.47	2.3	1.25	4.0	8.0	Q3
SN74LV1T04DCKR	SC70	DCK	5	3000	178.0	9.2	2.4	2.4	1.22	4.0	8.0	Q3

TAPE AND REEL BOX DIMENSIONS

*All dimensions are nominal

Device	Package Type	Package Drawing	Pins	SPQ	Length (mm)	Width (mm)	Height (mm)
SN74LV1T04DBVR	SOT-23	DBV	5	3000	180.0	180.0	18.0
SN74LV1T04DBVR	SOT-23	DBV	5	3000	202.0	201.0	28.0
SN74LV1T04DCKR	SC70	DCK	5	3000	202.0	201.0	28.0
SN74LV1T04DCKR	SC70	DCK	5	3000	180.0	180.0	18.0

DCK (R-PDSO-G5)

PLASTIC SMALL-OUTLINE PACKAGE



- NOTES:
- A. All linear dimensions are in millimeters.
 - B. This drawing is subject to change without notice.
 - C. Body dimensions do not include mold flash or protrusion. Mold flash and protrusion shall not exceed 0.15 per side.
 - D. Falls within JEDEC MO-203 variation AA.

DCK (R-PDSO-G5)

PLASTIC SMALL OUTLINE



- NOTES:
- A. All linear dimensions are in millimeters.
 - B. This drawing is subject to change without notice.
 - C. Customers should place a note on the circuit board fabrication drawing not to alter the center solder mask defined pad.
 - D. Publication IPC-7351 is recommended for alternate designs.
 - E. Laser cutting apertures with trapezoidal walls and also rounding corners will offer better paste release. Customers should contact their board assembly site for stencil design recommendations. Example stencil design based on a 50% volumetric metal load solder paste. Refer to IPC-7525 for other stencil recommendations.

GENERIC PACKAGE VIEW

DBV 5

SOT-23 - 1.45 mm max height

SMALL OUTLINE TRANSISTOR



Images above are just a representation of the package family, actual package may vary.
Refer to the product data sheet for package details.

4073253/P

DBV0005A



PACKAGE OUTLINE

SOT-23 - 1.45 mm max height

SMALL OUTLINE TRANSISTOR



4214839/C 04/2017

NOTES:

1. All linear dimensions are in millimeters. Any dimensions in parenthesis are for reference only. Dimensioning and tolerancing per ASME Y14.5M.
2. This drawing is subject to change without notice.
3. Reference JEDEC MO-178.

EXAMPLE BOARD LAYOUT

DBV0005A

SOT-23 - 1.45 mm max height

SMALL OUTLINE TRANSISTOR



LAND PATTERN EXAMPLE
EXPOSED METAL SHOWN
SCALE:15X



SOLDER MASK DETAILS

4214839/C 04/2017

NOTES: (continued)

- 4. Publication IPC-7351 may have alternate designs.
- 5. Solder mask tolerances between and around signal pads can vary based on board fabrication site.

EXAMPLE STENCIL DESIGN

DBV0005A

SOT-23 - 1.45 mm max height

SMALL OUTLINE TRANSISTOR



SOLDER PASTE EXAMPLE
BASED ON 0.125 mm THICK STENCIL
SCALE:15X

4214839/C 04/2017

NOTES: (continued)

6. Laser cutting apertures with trapezoidal walls and rounded corners may offer better paste release. IPC-7525 may have alternate design recommendations.
7. Board assembly site may have different recommendations for stencil design.

IMPORTANT NOTICE

Texas Instruments Incorporated (TI) reserves the right to make corrections, enhancements, improvements and other changes to its semiconductor products and services per JESD46, latest issue, and to discontinue any product or service per JESD48, latest issue. Buyers should obtain the latest relevant information before placing orders and should verify that such information is current and complete.

TI's published terms of sale for semiconductor products (<http://www.ti.com/sc/docs/stdterms.htm>) apply to the sale of packaged integrated circuit products that TI has qualified and released to market. Additional terms may apply to the use or sale of other types of TI products and services.

Reproduction of significant portions of TI information in TI data sheets is permissible only if reproduction is without alteration and is accompanied by all associated warranties, conditions, limitations, and notices. TI is not responsible or liable for such reproduced documentation. Information of third parties may be subject to additional restrictions. Resale of TI products or services with statements different from or beyond the parameters stated by TI for that product or service voids all express and any implied warranties for the associated TI product or service and is an unfair and deceptive business practice. TI is not responsible or liable for any such statements.

Buyers and others who are developing systems that incorporate TI products (collectively, "Designers") understand and agree that Designers remain responsible for using their independent analysis, evaluation and judgment in designing their applications and that Designers have full and exclusive responsibility to assure the safety of Designers' applications and compliance of their applications (and of all TI products used in or for Designers' applications) with all applicable regulations, laws and other applicable requirements. Designer represents that, with respect to their applications, Designer has all the necessary expertise to create and implement safeguards that (1) anticipate dangerous consequences of failures, (2) monitor failures and their consequences, and (3) lessen the likelihood of failures that might cause harm and take appropriate actions. Designer agrees that prior to using or distributing any applications that include TI products, Designer will thoroughly test such applications and the functionality of such TI products as used in such applications.

TI's provision of technical, application or other design advice, quality characterization, reliability data or other services or information, including, but not limited to, reference designs and materials relating to evaluation modules, (collectively, "TI Resources") are intended to assist designers who are developing applications that incorporate TI products; by downloading, accessing or using TI Resources in any way, Designer (individually or, if Designer is acting on behalf of a company, Designer's company) agrees to use any particular TI Resource solely for this purpose and subject to the terms of this Notice.

TI's provision of TI Resources does not expand or otherwise alter TI's applicable published warranties or warranty disclaimers for TI products, and no additional obligations or liabilities arise from TI providing such TI Resources. TI reserves the right to make corrections, enhancements, improvements and other changes to its TI Resources. TI has not conducted any testing other than that specifically described in the published documentation for a particular TI Resource.

Designer is authorized to use, copy and modify any individual TI Resource only in connection with the development of applications that include the TI product(s) identified in such TI Resource. NO OTHER LICENSE, EXPRESS OR IMPLIED, BY ESTOPPEL OR OTHERWISE TO ANY OTHER TI INTELLECTUAL PROPERTY RIGHT, AND NO LICENSE TO ANY TECHNOLOGY OR INTELLECTUAL PROPERTY RIGHT OF TI OR ANY THIRD PARTY IS GRANTED HEREIN, including but not limited to any patent right, copyright, mask work right, or other intellectual property right relating to any combination, machine, or process in which TI products or services are used. Information regarding or referencing third-party products or services does not constitute a license to use such products or services, or a warranty or endorsement thereof. Use of TI Resources may require a license from a third party under the patents or other intellectual property of the third party, or a license from TI under the patents or other intellectual property of TI.

TI RESOURCES ARE PROVIDED "AS IS" AND WITH ALL FAULTS. TI DISCLAIMS ALL OTHER WARRANTIES OR REPRESENTATIONS, EXPRESS OR IMPLIED, REGARDING RESOURCES OR USE THEREOF, INCLUDING BUT NOT LIMITED TO ACCURACY OR COMPLETENESS, TITLE, ANY EPIDEMIC FAILURE WARRANTY AND ANY IMPLIED WARRANTIES OF MERCHANTABILITY, FITNESS FOR A PARTICULAR PURPOSE, AND NON-INFRINGEMENT OF ANY THIRD PARTY INTELLECTUAL PROPERTY RIGHTS. TI SHALL NOT BE LIABLE FOR AND SHALL NOT DEFEND OR INDEMNIFY DESIGNER AGAINST ANY CLAIM, INCLUDING BUT NOT LIMITED TO ANY INFRINGEMENT CLAIM THAT RELATES TO OR IS BASED ON ANY COMBINATION OF PRODUCTS EVEN IF DESCRIBED IN TI RESOURCES OR OTHERWISE. IN NO EVENT SHALL TI BE LIABLE FOR ANY ACTUAL, DIRECT, SPECIAL, COLLATERAL, INDIRECT, PUNITIVE, INCIDENTAL, CONSEQUENTIAL OR EXEMPLARY DAMAGES IN CONNECTION WITH OR ARISING OUT OF TI RESOURCES OR USE THEREOF, AND REGARDLESS OF WHETHER TI HAS BEEN ADVISED OF THE POSSIBILITY OF SUCH DAMAGES.

Unless TI has explicitly designated an individual product as meeting the requirements of a particular industry standard (e.g., ISO/TS 16949 and ISO 26262), TI is not responsible for any failure to meet such industry standard requirements.

Where TI specifically promotes products as facilitating functional safety or as compliant with industry functional safety standards, such products are intended to help enable customers to design and create their own applications that meet applicable functional safety standards and requirements. Using products in an application does not by itself establish any safety features in the application. Designers must ensure compliance with safety-related requirements and standards applicable to their applications. Designer may not use any TI products in life-critical medical equipment unless authorized officers of the parties have executed a special contract specifically governing such use. Life-critical medical equipment is medical equipment where failure of such equipment would cause serious bodily injury or death (e.g., life support, pacemakers, defibrillators, heart pumps, neurostimulators, and implantables). Such equipment includes, without limitation, all medical devices identified by the U.S. Food and Drug Administration as Class III devices and equivalent classifications outside the U.S.

TI may expressly designate certain products as completing a particular qualification (e.g., Q100, Military Grade, or Enhanced Product). Designers agree that it has the necessary expertise to select the product with the appropriate qualification designation for their applications and that proper product selection is at Designers' own risk. Designers are solely responsible for compliance with all legal and regulatory requirements in connection with such selection.

Designer will fully indemnify TI and its representatives against any damages, costs, losses, and/or liabilities arising out of Designer's non-compliance with the terms and provisions of this Notice.